

**INDIA'S
LEADING MANUFACTURER**



INDIAN Fence Machine



MADE IN INDIA



INDIAN
Fence Machine



MADE IN INDIA





MADE IN INDIA



INDIAN
Fence Machine

About INDIAN Fence Machine

INDIAN Fence Machine is based in Udaipur Rajasthan and builds automated fencing machinery for contractors fabricators and industrial projects across India. The focus is dependable chain-link production with fast setup high speed and consistent quality, backed by Pan-India service for installation training spares and support.



What we make

The range includes fully automatic chain-link machines plus barbed wire and grassland fence solutions so you can cover end-to-end manufacturing from one partner.



How we work

Practical automation is at the heart of every build. Machines are easy to operate deliver single-operator productivity use robust PLC and servo control and are engineered for steady round-the-clock performance.



ISO 9001-2015



ISO 14001-2015



GMP





WHY CHOOSE US



Guided install and hands-on training for quick start-up and confident first production runs.



Single-operator, PLC-driven automation that delivers high speed, consistent mesh and safer operation



Fast-response after-sales support with spares availability to keep uptime high and stoppages low.



Robust build quality for continuous, 24-hour operations in demanding industrial environments.



PAN-India reach with remote diagnostics and on-site assistance when required.



End-to-end lineup: chain-link, gabion, barbed wire and grassland fence machinery.



Lower total production cost through efficiency, reduced rework, and optimized changeovers.



Future-ready controls and upgrade paths to scale output as your demand grows.



Customer-first service culture focussed on reliability, training, and quick turnaround.



Transparent process: need assessment, tailored configuration, installation, and lifecycle support.





MADE IN INDIA



INDIAN
Fence Machine

WHERE OUR FENCES WORK



Industrial sites

Secure yards and equipment while keeping visibility for safety patrols

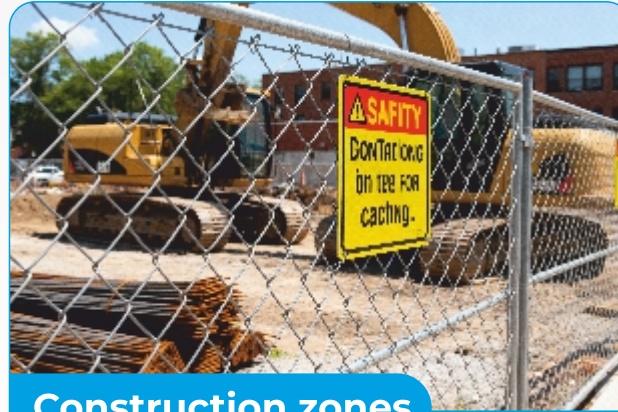

Construction zones

Fast perimeter control for material storage and worker access.



Sports facilities

Keep play inside the lines with clear viewing for spectators.



Farms and livestock

Protect animals and crops with durable all-weather fencing.

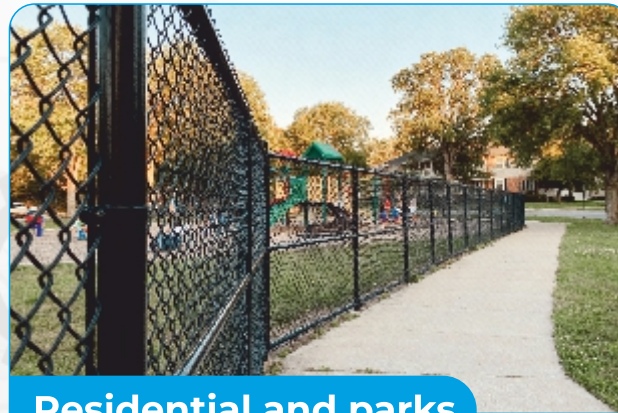

Residential and parks

Define property lines and safe play areas with low-maintenance mesh.



Utilities and infrastructure

Restrict access to critical assets with compliant perimeter control.



INDIAN
Fence Machine



MADE IN INDIA



DOUBLE WIRE CHAIN LINK FENCING MACHINE

Chetak
Model **2026**

Automatic Border Wire Machine Option Available

- 2X Production
- Low Production Cost
- Low Inventory Cost
- Lower maintenance

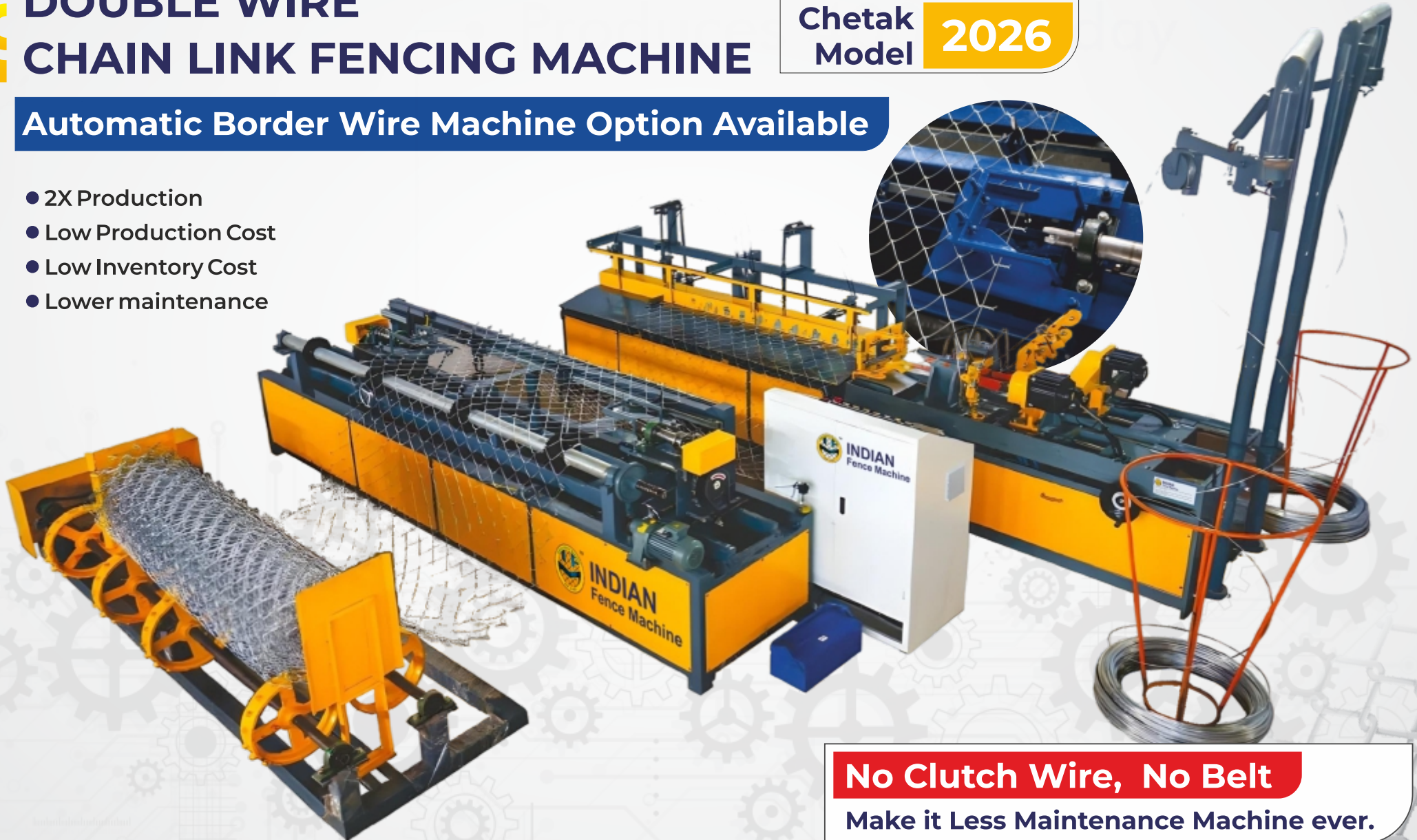

No Clutch Wire, No Belt
Make it Less Maintenance Machine ever.



MADE IN INDIA



INDIAN
Fence Machine

POWER



- ◆ Connected Load :18 HP
- ◆ Running Load :13-14 HP
- ◆ No. of Motors :9

SPECIFICATIONS



- ◆ Space Required: 24x20 ft
- ◆ Mesh Size: 35–110 mm
- ◆ Wire Dia:
 - GI: 2–4 mm
 - PVC: 3–5.5 mm

ACCESSORIES



- ◆ Moulds – 8 dyes
- ◆ Professional Tool Kit
- ◆ Extra Relay
- ◆ Oil Dispenser
- ◆ Gloves
- ◆ Wheels & Extra Spares
- ◆ Compactor (Optional)
- ◆ SMPS Sensors & SSR etc.

ABOUT MACHINE



- ◆ Cutting machine: Delta servo system 6HPx2 with Reducer (Oil/grease free gearbox)
- ◆ Without Clutch wire & Belt
- ◆ Electric Panel: Delta & Schneider Electrics
- ◆ Wire Pay-Off Stand: 500kgs capacity
- ◆ Weaving Machine: Heavy duty Drive motor+gear
- ◆ Locking Part (New Model: Twist/Knuckle)
- ◆ Auto roller with motor
- ◆ Easy adjustable 'T' screws
- ◆ Auto-tune servo system
- ◆ Fully remote control
- ◆ Durable powder coat for anti-corrosion, anti-scratch, fade- and chip-resistance.

PRODUCTION



- ◆ 4 mm – 200–220 KG (Per Hour)
- ◆ 3 mm – 180–200 KG (Per Hour)
- ◆ 2.5 mm – 150–160 KG (Per Hour)
- ◆ 2 mm – 100–120 KG (Per Hour)

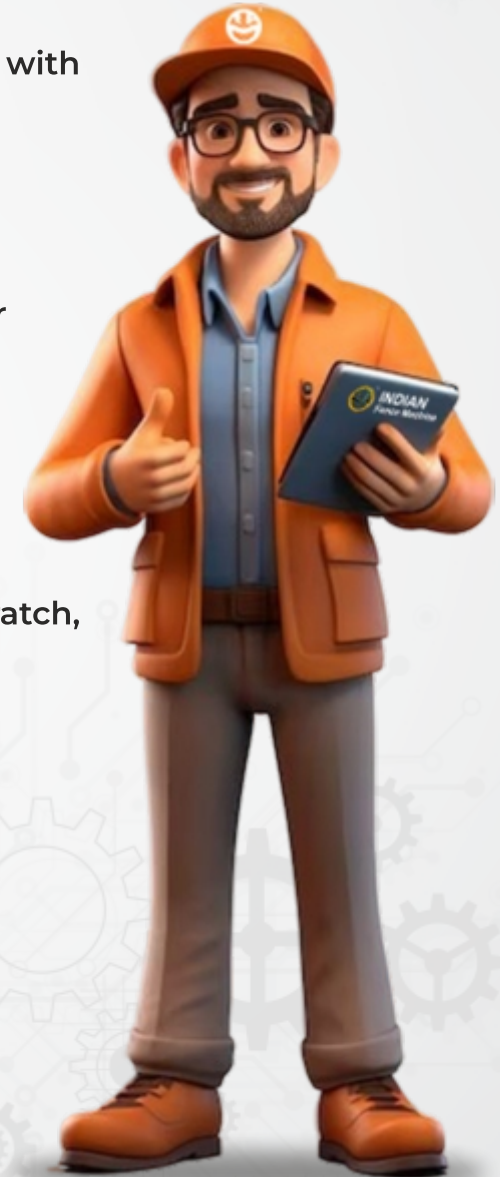

Power your fence production with precision machines that start fast run steady and deliver consistent mesh every shift.



INDIAN
Fence Machine



MADE IN INDIA



FULLY AUTOMATIC CHAIN LINK FENCING MACHINE

Plus
Model **2026**

Automatic Border Wire Machine Option Available

- Single-operator workflow
- 24x7 continuous-duty design
- Lower maintenance
- Low Production Cost

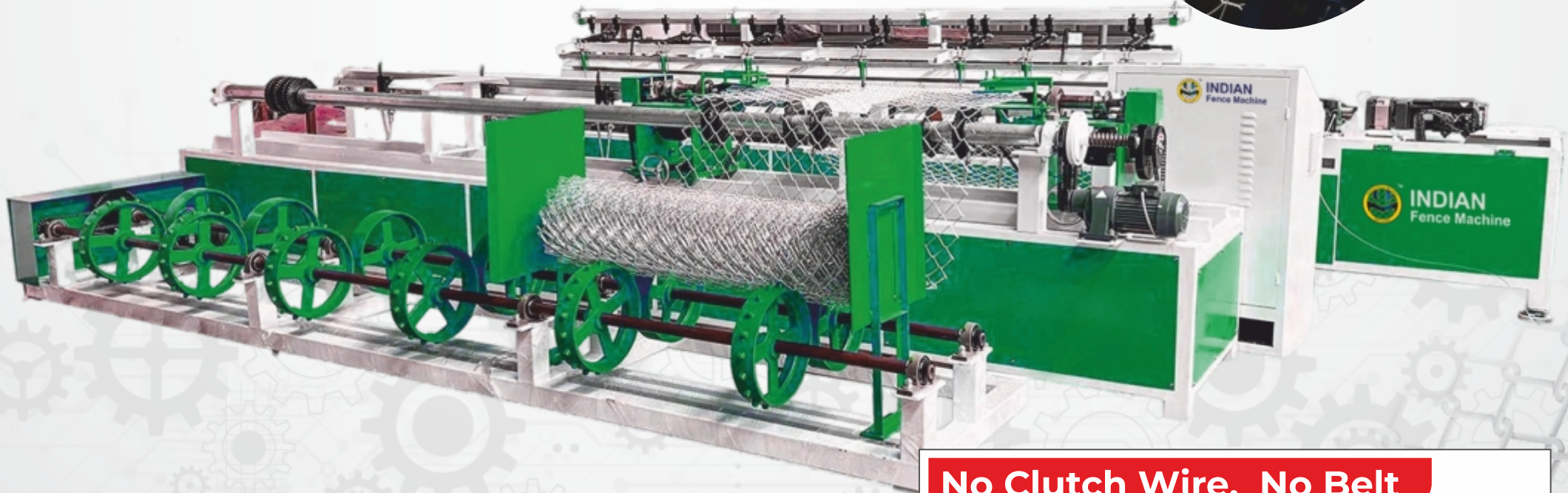

No Clutch Wire, No Belt

Make it Less Maintenance Machine ever.



MADE IN INDIA



INDIAN
Fence Machine

POWER



- ◆ Connected Load : 12 HP
- ◆ Running Load : 8-9 HP
- ◆ No. of Motors : 8

SPECIFICATIONS



- ◆ Space Required: 20×20 ft
- ◆ Mesh size: 30 to 110 mm / 50 to 130 mm
- ◆ Wire Dia:
 - GI: 1.6–4 mm
 - PVC: 3–5.5 mm
 - SS(304): 1.6–4 mm

ACCESSORIES



- ◆ Moulds – 5 dyes
- ◆ Professional Tool Kit
- ◆ Extra Relay
- ◆ Oil Dispenser
- ◆ Gloves
- ◆ Wheels & Extra Spares
- ◆ Compactor (Optional)

ABOUT PRODUCT



- ◆ Cutting machine: Delta servo system 6HP with Reducer (Oil/grease free gearbox)
- ◆ Without Clutch wire & Belt
- ◆ Electric Panel: Delta & Schneider Electrics
- ◆ Wire Pay-Off Stand: 250kgs capacity
- ◆ Weaving Machine: Heavy duty Drive motor+gear
- ◆ Locking Part (New Model: Twist/Knuckle)
- ◆ Auto roller with motor
- ◆ Easy adjustable 'T' screws
- ◆ Auto-tune servo system
- ◆ Fully remote control
- ◆ Durable powder coat for anti-corrosion, anti-scratch, fade- and chip-resistance.

PRODUCTION



- ◆ 4.0 mm – 150–170 KG (Per Hour)
- ◆ 3.5 mm – 130–150 KG (Per Hour)
- ◆ 3.0 mm – 100–120 KG (Per Hour)
- ◆ 2.5 mm – 80–90 KG (Per Hour)
- ◆ 2 mm – 50–60 KG (Per Hour)
- ◆ 1.6 mm (Poultry Jali) – 35–40 KG (Per Hour)

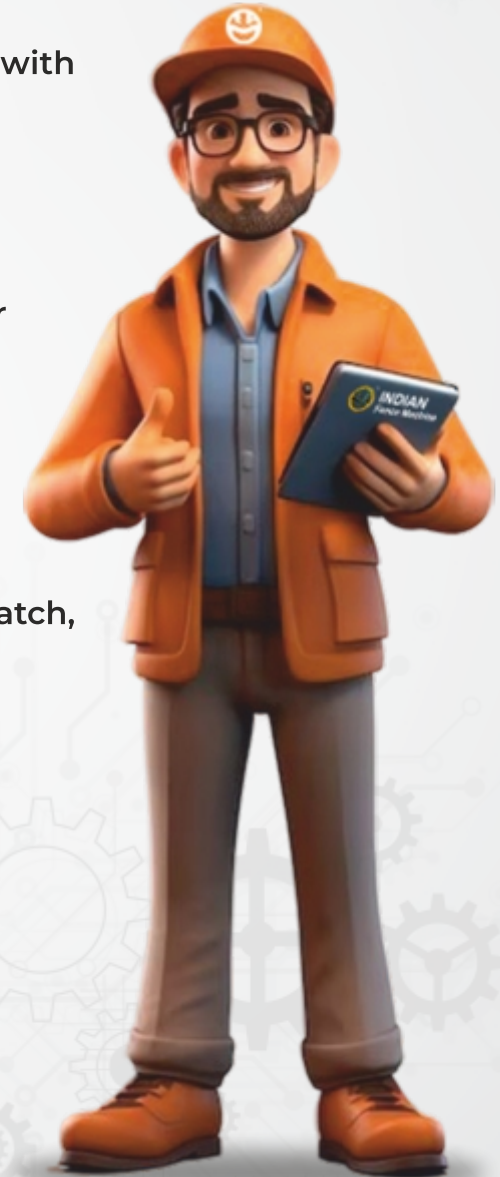

Power your fence production with precision machines that start fast run steady and deliver consistent mesh every shift.



INDIAN
Fence Machine



MADE IN INDIA



SEMI-AUTOMATIC CHAIN LINK FENCING MACHINE

Plus
Model **2026**

- Supports GI, PVC and SS wires
- Low routine maintenance
- Stable 24×7 performance
- Low Production Cost



No Clutch Wire, No Belt

Make it Less Maintenance Machine ever.



MADE IN INDIA



INDIAN
Fence Machine

POWER



- ◆ Connected Load : 9 HP
- ◆ No. of Motors : 3

SPECIFICATIONS



- ◆ Space Required: 20×8 ft
- ◆ Mesh size: 30 to 110 mm / 50 to 130 mm
- ◆ Wire Dia:
 - GI: 1.6–4 mm
 - PVC: 3–5.5 mm
 - SS(304): 1.6–4 mm

ACCESSORIES



- ◆ Moulds – 5 dyes
- ◆ Professional Tool Kit
- ◆ Extra Relay
- ◆ Oil Dispenser
- ◆ Gloves
- ◆ Wheels & Extra Spares
- ◆ Compactor (Optional)

ABOUT PRODUCT



- ◆ Cutting machine: Delta servo system 6HP with Reducer (Oil/grease free gearbox)
- ◆ Without Clutch wire & Belt
- ◆ Electric Panel: Delta & Schneider Electrics
- ◆ Wire Pay-Off Stand: 250kgs capacity
- ◆ Weaving Machine: Heavy duty Drive motor+gear
- ◆ Locking Part (New Model: Twist/Knuckle)
- ◆ Auto roller with motor
- ◆ Easy adjustable 'T' screws
- ◆ Auto-tune servo system
- ◆ Fully remote control
- ◆ Durable powder coat for anti-corrosion, anti-scratch, fade- and chip-resistance.

PRODUCTION



- ◆ 4.0 mm – 150–170 KG (Per Hour)
- ◆ 3.5 mm – 130–150 KG (Per Hour)
- ◆ 3.0 mm – 100–120 KG (Per Hour)
- ◆ 2.5 mm – 75–85 KG (Per Hour)
- ◆ 2 mm – 50–60 KG (Per Hour)
- ◆ 1.6 mm (Poultry Jali)– 35–40 KG (Per Hour)

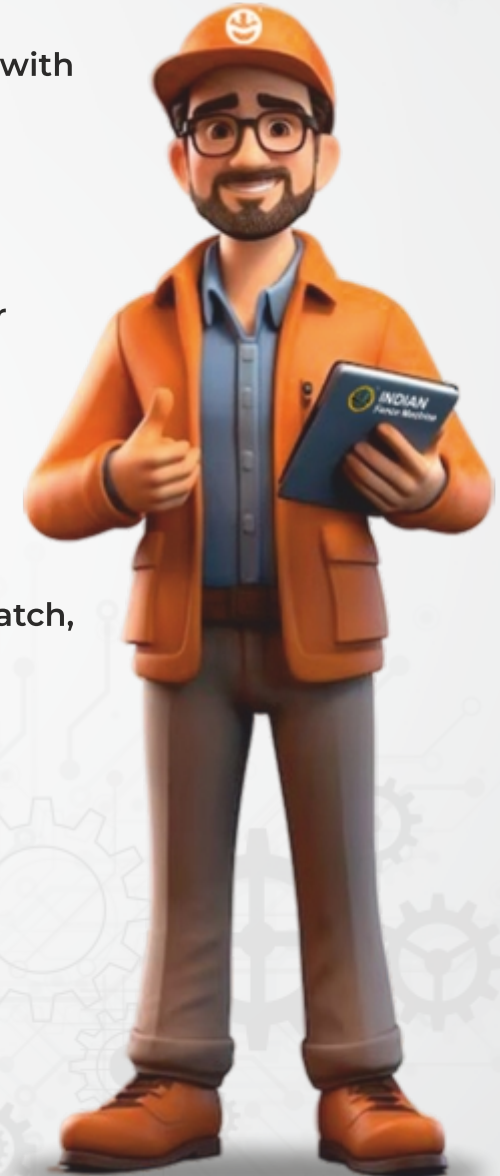

Power your fence production with precision machines that start fast run steady and deliver consistent mesh every shift.



INDIAN
Fence Machine



MADE IN INDIA

GRASSLAND FENCING MACHINE

STAFF REQUIREMENT



- ◆ 1 Operator
- ◆ 1 Helper

MACHINE PART



- ◆ Main Machine
- ◆ Mounted Electric Cabinet
- ◆ Mesh Rolling System
- ◆ Wire Straightening System
- ◆ 36 rear pay of stands

TECHNICAL INFORMATION



- | | |
|-------------------------------|--------------------------------|
| ◆ Strokes Min | 40-45 |
| ◆ Rolls | 4-5 rolls (100ft) |
| ◆ Roll Height | 3ft - 6ft |
| ◆ Wire Diameter (G.I.) | 12,13,14 swg or 2, 2.2, 2.5 mm |
| ◆ Mesh Size (Inch) | 4x4, 4x5, 4x6 or 5x4, 5x5, 5x6 |
| ◆ Power Consumption | 7.5 HP |





MADE IN INDIA



INDIAN
Fence Machine

HIGH SPEED BARBED WIRE MACHINE

BENEFITS



- ◆ High Speed Production (1500-2000kgs / 24hrs)
- ◆ The Perfect Barb Shape
- ◆ Less Noise
- ◆ Lowest Power Consumption & Cost of Production
- ◆ Lowest Inventory Costs & Maintenance

TECHNICAL INFORMATION



- ◆ **Wire Dia** 12/13/14 swg
- ◆ **Running Space Required** 15x7 ft
- ◆ **Power Consumption** 3HP/ 5HP
- ◆ **Barb Spacing** 90 to 100 mm
- ◆ **Speed** 120 to 150 barb / min

ACCESSORIES



- ◆ Tool Kit
- ◆ Standard Spare Parts

MACHINE PART



- ◆ Main Machine
- ◆ Electric Cabinet
- ◆ Wire Pay-off Stands-4pcs
- ◆ Final Spooler-2pcs



www.indianfencemachine.com



LIVE UP THE POWER

Our electronic panel uses a next-generation DELTA with a high-speed system bus that boosts throughput and control performance. It also integrates Schneider Electric components and a Touchwin touch screen for reliable operation and easy use.

6 HP SERVO MOTOR

- ◆ **Brand name** - Delta
- ◆ **Country** - Taiwan
- ◆ **Power** - 6 HP
- ◆ **Torque** - 28.65 NM
- ◆ **R/min** - 1500





MADE IN INDIA



INDIAN
Fence Machine

CHAIN LINK FENCE MACHINE CONTROL PANEL



High Quality Accessories

- ◆ SMPS Delta Company
- ◆ Drive Delta Company
- ◆ HMI Delta Company
- ◆ VFD Delta Company
- ◆ Wire Lapp Company
- ◆ Others Parts Schneider Company
- ◆ PLC Delta Company

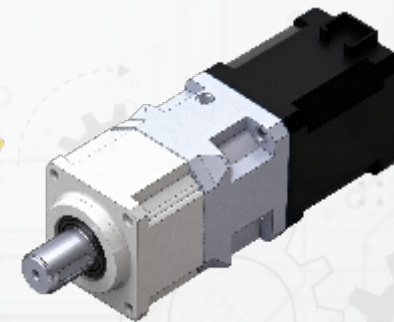

6 HP Delta Motor

- ◆ 6 HP Delta Motor
- ◆ Reducer (Oil/grease free gearbox)

Build Security Faster

Installation - Training - Support



भारत की विश्वसनीय फेंसिंग मशीन



इंडियन
फेंस मशीन

भरोसा जो चले लगातार



Request Quarry | WhatsApp
Scan to chat

INDIAN Fence Machine

Head Office

Contact No. +91-77426 54628, +91-95880 12014

Address- B-88, Udai Vihar Colony, Road No. 12, Opposite
Airtel Office, Udaipur 313001 (Raj.) INDIA

Tamilnadu Region

Contact No. +91-6350258857, +91-9057547167

Jharkhand Region

Contact No. +91-7851884975, +91-9509847423

Maharastra Region

Contact No. +91-8949159692, +91-6367827619

Email us on info@indiafencmachine.com

Visit on web www.indiafencmachine.com

Specifications may change without notice. Images are indicative.